

# PRO-LOCK

lockout tagout

LARGEST SELECTION OF  
LOCKOUT TAGOUT SAFETY  
PRODUCT AVAILABLE

ALUMINIUM & COMPOSITE  
PADLOCKS

PADLOCK ENGRAVING  
AVAILABLE

YOUR TRUSTED **LOCKOUT TAGOUT** SPECIALIST



## ALUMINUM SAFETY PALDOCK

Part No.	Specification	Description
ALP38S	Inner shackle:38mm; diameter:6mm	Support keyed differ, keyed alike, master keyed, and grand master keyed system.



- Aluminum body and triple-coated hardened chrome plated steel shackle.
- When unlocking the padlock, the shackle will pop up automatically.
- Normal color: RED, YLW, BLU, ORG, GRN, PRP, BLK, SLV.
- Other shackle lengths can be customized.



## SAFETY PADLOCK

Part No.	Shackle Material	A(mm)	B(mm)	C(mm)	Specification
WCP38S	Steel	41	45	38	Support keyed alike, keyed differ, master keyed and grand master keyed system. *1key/lock



- Made of copper cylinder and key. More resistant to corrosion and rust. Very stable, with more than 1 million times operating.
- Reinforced nylon body, withstand temperature from  $-20^{\circ}\text{C}$  to  $+120^{\circ}\text{C}$ . The steel shackle is chrome plated.
- Key Retaining Feature: When the shackle is open, the key can't be removed.
- All different colors available.



## SAFETY PADLOCK

Part No.	Description	Shackle Material	Specification
KA-P38P	Keyed Alike	Nylon	"P": Straight edge plastic lock body
KD-P38P	Keyed Differ		"P": Nylon shackle *1key/lock

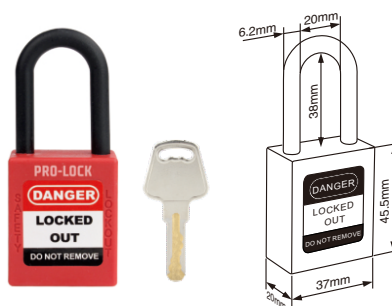

- Reinforced nylon body, withstand temperature from  $-20^{\circ}\text{C}$  to  $+120^{\circ}\text{C}$ . The steel shackle is chrome plated; the non-conductive shackle is made from nylon, withstand temperature from  $-20^{\circ}\text{C}$  to  $+120^{\circ}\text{C}$ , ensuring the strength and deformation fracture not easily.
- Key Retaining Feature: When the shackle is open, the key can't be removed.
- Laser printing and logo engraving available if required.
- All different colors available.



## ADJUSTABLE BALL VALVE LOCKOUT

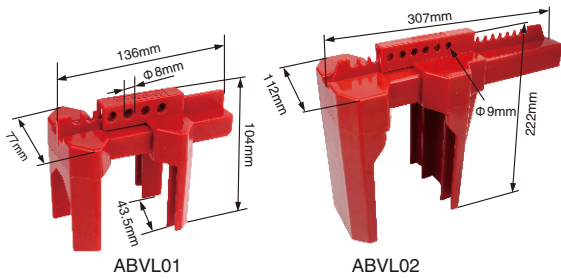

Part No.	Description
ABVL01	Suitable for pipes 1/2" to 2.5" in diameter, OPEN on pipes from 1/2" to 1.25"
ABVL02	Suitable for pipes 2" to 8" in diameter

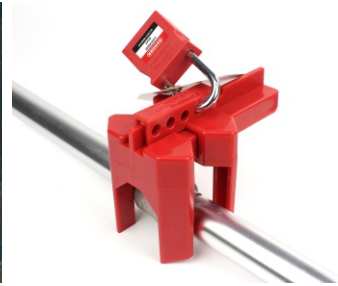

- Made from durable ABS, withstand temperature from  $-20^{\circ}\text{C}$  to  $+90^{\circ}\text{C}$ , highly resistant of cracking and abrasion and supports extreme weather temperature conditions.
- The two halves of the lockout encompass the ball valve handle to secure it from inadvertent activation of the valve handle.

## ADJUSTABLE FLANGED BALL VALVE LOCKOUT

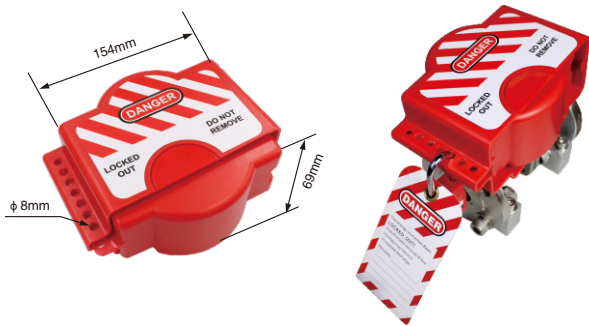

Part No.	Description
FBVL01	Suitable for 6.35mm(1/4") to 140mm(5") flanged ball valves

- Made from durable ABS, withstand temperature from  $-20^{\circ}\text{C}$  to  $+90^{\circ}\text{C}$ .
- Accept up to 1 padlock, locking shackle max diameter 8mm.
- Available in red color, other colors can be customized, providing English tags.

## ADJUSTABLE GATE VALVE LOCKOUT

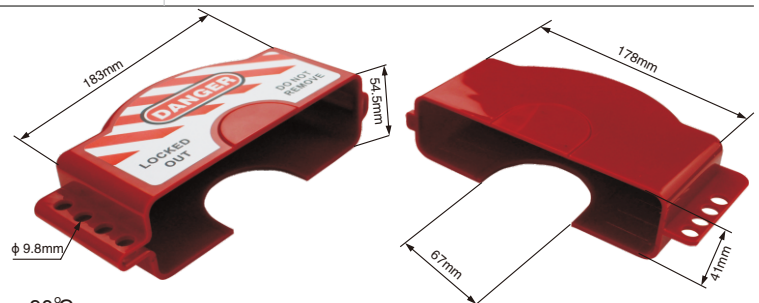

Part No.	Description
AGVL01	Suitable for valve handle 1" to 6 1/2" in diameter

- Made from durable ABS, withstand temperature from  $-20^{\circ}\text{C}$  to  $+90^{\circ}\text{C}$ .
- Can be equipped together with padlocks. Padlock locking shackle max diameter 3/8"(9.8mm).
- Can be covered and rotated freely around valve wheel, and adjustable to fit a range of valve handles.

Part No.	Description	A	B	C
SGVL01	Suitable for valve handle 1" to 2 1/2" in diameter	80	30	20
SGVL02	Suitable for valve handle 2 1/2" to 5" in diameter	142	37	45
SGVL03	Suitable for valve handle 5" to 6 1/2" in diameter	184	44	63
SGVL04	Suitable for valve handle 6 1/2" to 10" in diameter	280	67	89
SGVL05	Suitable for valve handle 10" to 13" in diameter	364	67	105

- Made from durable ABS, withstand temperature from -20°C to +90°C.
- Once locked, it covers around the hand wheel and prevent the valve wheel from being turned.
- Accept up to 1 padlock, locking shackle max diameter 9.8mm.
- Available in 5 sizes and red color, other colors can be customized, providing English tag.

## STANDARD GATE VALVE LOCKOUT

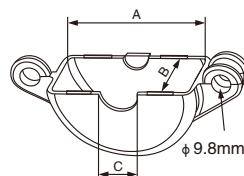

## ADJUSTABLE STEEL CABLE LOCKOUT

Part No.	Description
CB01-4	Cable diameter 4mm, length 2m
CB01-6	Cable diameter 6mm, length 2m

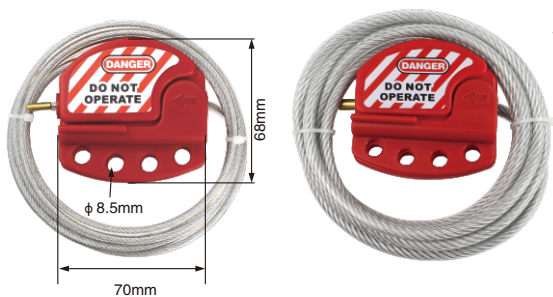

CB01-4

CB01-6

- Lock body: made of ABS, withstands chemicals.
- Cable: tough, flexible multi-stranded steel cable, with clear plastic insulation coating.
- Cable length can be customized.
- Accepts up to 4 padlocks for multiple lockout application.



- Includes high-visibility, re-usable, write-on safety labels. Can be customized.
- Ideal for locking out a single valve or multiple side-by-side valves.

## ADJUSTABLE STEEL CABLE LOCKOUT

Part No.	Description
CB03	Cable diameter 3.8mm, length 2m

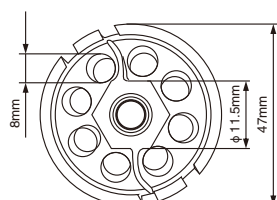

Step1

Step2

Step3

- Made from industrial durable nylon, and insulation coated steel cable.
- Designed to effectively lock out a variety of isolation points, including gate valves, "T" valve handles and other hard-to-secure mechanical devices.
- The handle is designed to operate the device without any tools needed.
- Cable length and color can be customized.
- Accepts up to 8 padlocks for multiple lockout application.

Part No.	Material	Description
CS01-2.5S-256	Aluminum alloy body, with galvanized cable	Cable diameter 2.5mm, length 256mm
CS01-2.5S-1000	Aluminum alloy body, with galvanized cable	Cable diameter 2.5mm, length 1000mm
CS02-1.8S-256	ABS body, with steel cable	Cable diameter 1.8mm, length 256mm
CS02-1.8P-256	ABS body, with insulation coated steel cable	Cable diameter 1.8mm, length 256mm

- ⊙ Ideal for long term uses, each car seal is self locking. The only way to remove it is by cutting after the cable passed through the body.
- ⊙ All car seals can be laser printed with individually numbering.
- ⊙ The length of the cable can be customized.
- ⊙ Colors can be customized, normally in red, yellow, green and blue.

## SECURITY SEAL LOCKOUT

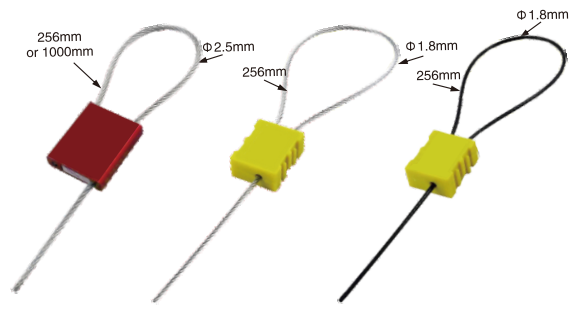

CS01-2.5S-256/1000      CS02-1.8S-256      CS02-1.8P-256

## MINIATURE CIRCUIT BREAKER LOCKOUT

Part No.	Description
TBLO	TBLO (Tie Bar Lockout), no hole in breakers required

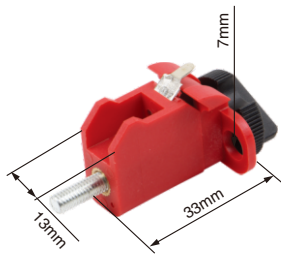

- ⊙ Made from engineering plastic strengthened nylon PA.
- ⊙ Applied for most existing types of European and Asian circuit breakers.
- ⊙ Suggest to be equipped together with a padlock.
- ⊙ Easily installed, no tools needed.
- ⊙ Can take a padlock with shackle diameter up to 9/32"(7mm).
- ⊙ Available for multi-pole breakers.

## CIRCUIT BREAKER LOCKOUT

Part No.	Description
CBL02-1	lock hole:9mm, max clamping 10.5mm, need a small screw driver to install.
CBL02-2	lock hole:9mm, max clamping 10.5mm, without installing tools needed.
CBL02-3	lock hole:10mm, max clamping 10.5mm, without installing tools needed.

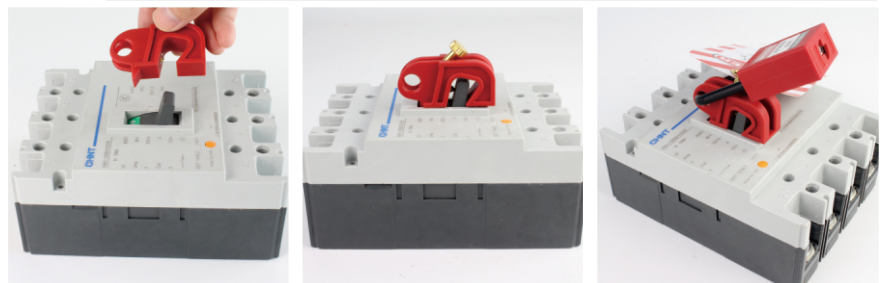
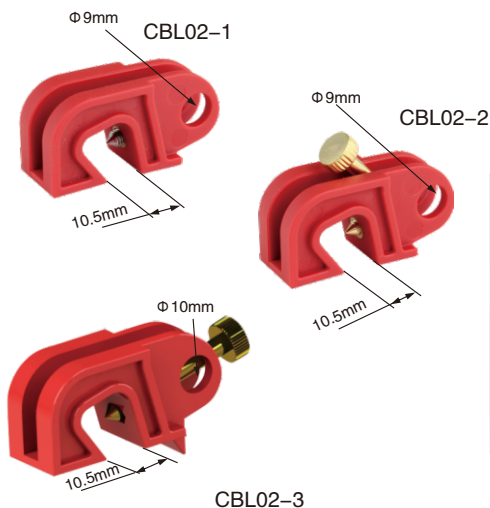

- ⊙ Made from engineering plastic strengthened nylon PA.
- ⊙ Lock out different types of circuit breakers.

## CLAMP-ON CIRCUIT BREAKER LOCKOUT

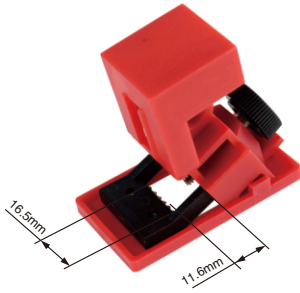

Part No.	Description
CBL11	For 120–277V breaker lockouts, handle width ≤16.5mm



- Made of rugged polypropylene and impact modified nylon.
- Can be easily operated without any tools.
- Can be used with lockout cleats in the bottom for hard locking long sliding switches and switches with large angular rotation.
- Accepts lock shackles up to 9/32" (7.5mm) in diameter.

Part No.	Description
CBL11-2	Dedicated to Schneider circuit breakers EZD below 100A
CBL11-3	Dedicated to Schneider circuit breaker EZD between 160~250A

## CIRCUIT BREAKER LOCKOUT

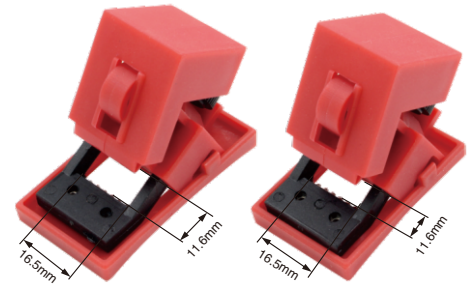

CBL11-3

CBL11-2

- Made of rugged polypropylene and impact modified nylon, temperature resistance  $-5^{\circ}\text{C}$  to  $+100^{\circ}\text{C}$ .
- Can be easily operated without any tools.
- Accepts lock shackles up to 9/32" (7.5mm) in diameter.

## CLAMP-ON CIRCUIT BREAKER LOCKOUT

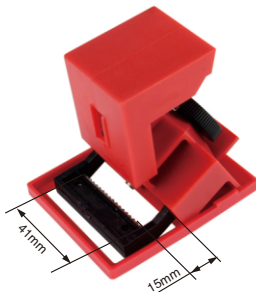

Part No.	Description
CBL12	For 480–600V breaker lockouts, handle width ≤41mm



- Made of rugged polypropylene and impact modified nylon.
- Can be easily operated without any tools.
- Can be used with lockout cleats in the bottom for hard locking long sliding switches and switches with large angular rotation.
- Accepts lock shackles up to 9/32" (7.5mm) in diameter.

## MULTI-FUNCTIONAL CIRCUIT BREAKER LOCKOUT

Part No.	Description
CBL41	Suitable for locking out multi-pole breakers and works with most tie-bar toggles

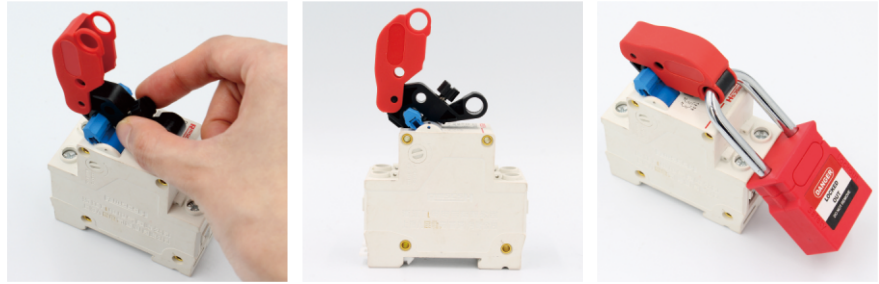

- Made from engineering plastic strengthened nylon PA, temperature resistance  $-20^{\circ}\text{C}$  to  $+120^{\circ}\text{C}$ .
- Compact size allows for locking out adjacent breakers.
- Comes with a locking screw, you can easily lock without using other locking tools. Slotting allows screwdriver adjustment.
- Can take a padlock with shackle diameter up to 8.5mm.

## ELECTRICAL PLUG LOCKOUT

Part No.	Description	A	B	C	d1
EPL04	Suitable for plugs $\leq 58\text{mm}$ in size	110	70	21	7
EPL05	Suitable for plugs $\leq 78\text{mm}$ in size	190	90	25	7

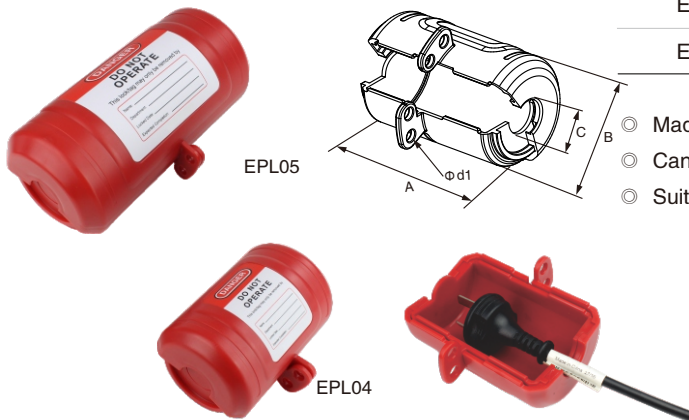

- Made of ABS engineering plastic, Temperature resistance  $-20^{\circ}\text{C}$  to  $+90^{\circ}\text{C}$ .
- Can be managed by 2 person at the same time.
- Suitable for industrial and domestic plug locking.

## CYLINDER TANK LOCKOUT

Part No.	A	B	C	D
ASL03	92	40	33	45
ASL03-2	83	37	/	31

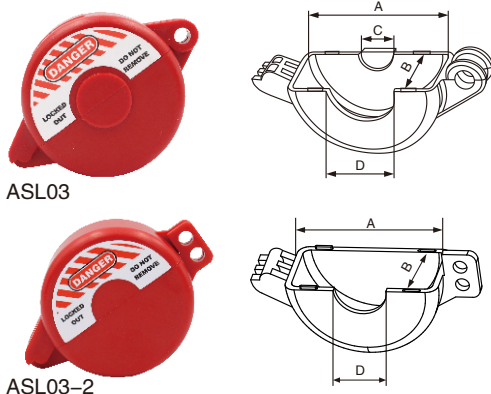

- Made from durable ABS.
- The whole product is metal-free for superior spark proof and chemical resistance.
- Resistant to cracking and abrasion extreme weather and temperature conditons.
- Can be equipped together with hasps and padlocks.

## STEEL LOCKOUT HASP

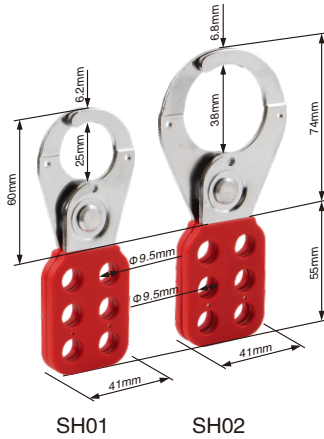

Part No.	Description
SH01	Jaw Size 1"(25mm), accept up to 6 padlocks.
SH02	Jaw Size 1.5"(38mm) , accept up to 6 padlocks.

- Handle is made from PA and lock shackle is made from chrome plated steel with red plastic or vinyl coated body, rust proof.
- Allow multiple padlocks to be used when isolating one energy source.
- Lock holes: 9.5mm in diameter.
- Jaw size: 1"(25mm) & 1.5"(38mm).

## NYLON LOCKOUT HASP

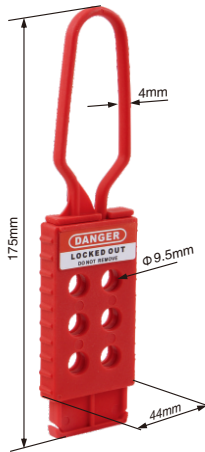

Part No.	Description
NH01	Overall size: 44 x 175mm, accept up to 6 padlocks.

- Made from durable nylon.
- Non-conductive body, applied to electric power isolation with high requirements on corrosive and explosion-proof places.
- Allow multiple padlocks to be used when isolating one energy source.
- Labels can be customized.

## SAFETY WARNING TAG

- Made from PVC material.
- The tag indicates who is responsible for placing the lockout device and who is authorized to remove it or make changes to it.
- Can be written by erasable pen for repeated using.
- Other wording and design can be custom made.

Part No.	Description
LT02	75mm(W) x 146mm(H) x 0.5mm(T)



LT02

## SAFETY WARNING TAG

- Made from PVC material.
- The tag indicates who is responsible for placing the lockout device and who is authorized to remove it or make changes to it.
- Can be written by erasable pen for repeated using.
- Other wording and design can be custom made.

Part No.	Description
LT01	75mm(W) × 146mm(H) × 0.5mm(T)
LT03	75mm(W) × 146mm(H) × 0.5mm(T)



LT01

LT03

## SCAFFOLD HOLDER TAG



SLT01

SLT01-T

Part No.	Description
SLT01	Size: 310mm × 92mm, hole diameter: 60mm, 1 tag with 1 holder.

- Made from ABS.
- Provides systematic, procedural and legal compliance for scaffolds on work sites.
- Provides a clear inspection trail giving integrity and control of work carried out.
- The tags are available in three durable write-on materials, providing highly visual and eye-catching information.
- Each with a scaffold tag holder and a tag. The tags can be customized.

## PORTABLE GROUP LOCK BOX

- Made from surface high temperature spraying plastic treatment steel plate and stainless steel nylon handle.
- Several people can lock the important parts at the same time.
- Can be used as mini portable lockout box, can accommodate several tagout, hasp, mini lockout etc.
- The label message in English. Other language can be custom made.

Part No.	Description
LK01	Size: 227mm(W) × 152mm(H) × 88mm(D), can accommodate 12 padlocks.



Part No.	Description
LK03	360mm(W) × 450mm(H) × 163mm(D)

- Made from surface high temperature spraying plastic treatment steel plate.
- There are two adjustable separators which can allocate spaces easily.
- The station is multifunctional for all kinds of lockouts, especially for departmental usage.
- Can be customized made non-perspective panel.
- Any size station can be customized.

## MANAGEMENT LOCKOUT STATION



Part No.	Description
LK21	165mm(W) × 325mm(H) × 85mm(D)

- ⊙ Made from surface high temperature spraying plastic treatment steel plate and stainless steel and nylon handle.
- ⊙ Device design for key store when large scale equipment shut down.
- ⊙ Can be used as mini portable lockout box, can accommodate several tagout, hasps, mini lockout etc.
- ⊙ Double function: wall mounting type or portable.
- ⊙ Integrated store space can accommodate 12 padlocks orderly or hundreds of keys scatteredly.
- ⊙ Up to 14 workers can lock it at the same time.
- ⊙ Other colors can be customized.

## GROUP LOCKOUT BOX

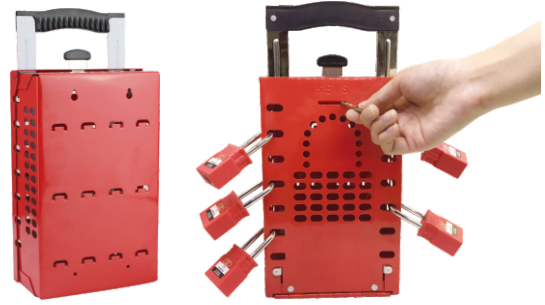

Part No.	Description
LS01	410mm(W) × 315mm(H) × 65mm(D)
LS02	565mm(W) × 400mm(H) × 65mm(D)
LS03	565mm(W) × 400mm(H) × 65mm(D), with holder for small lockout devices.

## LOCKOUT STATION



LS01

LS02

- ⊙ Made from engineering plastic PC.
- ⊙ One piece design, with a cover to lock out.
- ⊙ Can accommodate padlocks, hasps, lockout tags and some ties.
- ⊙ There's a lockable combination padlock hole for locking out as a limit access to unauthorized employees.

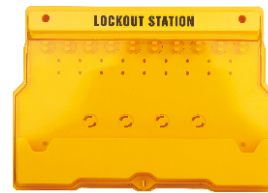

LS03



Part No.	Description
Ls32	Can accommodate 40 padlocks, 4 hasps and tags.

## LOCKOUT STATION

- ⊙ The lockout station is made of engineering plastic ABS with transparent PC cover.
- ⊙ The pc cover protects the inside lockouts from dust and missing. It can accommodate padlocks, hasps, lockout tags and some other lockout devices.
- ⊙ There is an overall padlock hole to lock out the station and preventing the stored lockouts inside from unauthorized employees.
- ⊙ The overall size: 603mm(W) × 600mm(H) × 66.8mm(D).



LS32

Part No.	Products	Description	Part No.	Products	Description
LG03		<p>Lockout kit Box (PLK11) × 1;  Lockout Hasp (SH01) × 2;  Lockout Hasp (SH02) × 2;  Safety Padlock (P38S-RED) × 4;  Lockout Hasp (NH01) × 2;  Cable Lockout (CB01-6) × 1;  Valve Lockout (AGVL01) × 1;  Valve Lockout (ABVL01) × 1;  Breaker Lockout (CBL11) × 2;  Breaker Lockout (CBL12) × 1;  Breaker Lockout (TBLO) × 2;  Lockout Tag (LT03) × 12.</p>	LG41		<p>Lockout bag (LB41) 1PC;  Safety padlock (P38S-RED) × 1;  Safety padlock (PC175-RED) × 1;  Lockout tag (LT03) × 12;  Breaker lockout (CBL32) × 2;  Breaker lockout (CBL31) × 1;  Lockout hasp (SH01) × 1;</p>